

# \*TB 9-6625-2352-35

DEPARTMENT OF THE ARMY TECHNICAL BULLETIN

## CALIBRATION PROCEDURE FOR ANALOG MULTIMETERS 0 TO 6000 VOLTS (GENERAL)

Headquarters, Department of the Army, Washington, DC  
3 June 2005

*Distribution Statement A: Approved for public release; distribution is unlimited*

### REPORTING OF ERRORS AND RECOMMENDING IMPROVEMENTS

You can improve this manual. If you find any mistakes or if you know of a way to improve these procedures, please let us know. Mail your letter or DA Form 2028 (Recommended Changes to Publications and Blank Forms) directly to: Commander, US Army Aviation and Missile Command, AMSAM-MMC-MA-NP, Redstone Arsenal, AL 35898-5000. A reply will be furnished to you. You may also provide DA Form 2028 information to AMCOM via e-mail, fax, or the World Wide Web. Our fax number is DSN 788-6546 or Commercial 256-842-6546. Our e-mail address is [2028@redstone.army.mil](mailto:2028@redstone.army.mil). Instructions for sending an electronic 2028 may be found at the back of this manual. For the World Wide Web, use <https://amcom2028.redstone.army.mil>.

SECTION		Paragraph	Page
I.	IDENTIFICATION AND DESCRIPTION		
	Test instrument identification .....	1	2
	Forms, records and reports.....	2	2
	Calibration description .....	3	2
II.	EQUIPMENT REQUIREMENTS		
	Equipment required .....	4	3
	Accessories required .....	5	3
III.	CALIBRATION PROCESS		
	Preliminary instructions .....	6	3
	Equipment setup .....	7	4
	Dc voltage .....	8	4
	Ac voltage.....	9	4
	Resistance .....	10	5
	Dc current .....	11	5
	Final procedure .....	12	31

\*This bulletin supersedes TB 9-6625-2352-35, dated 15 April 2004.

**SECTION I  
IDENTIFICATION AND DESCRIPTION**

**1. Test Instrument Identification.** This bulletin provides instructions for the calibration of Analog Multimeters 0 to 6000 Volts (General) listed in table 1. The manufacturers' manuals or TMs were used as the prime data sources in compiling these instructions. The equipment being calibrated will be referred to as the TI (test instrument) throughout this bulletin.

**a. Model Variations.** Variations among models are described in text, tables and figures.

**b. Time and Technique.** The time required for each calibration is approximately 2 hours, using the dc and low frequency technique.

**2. Forms, Records, and Reports**

**a.** Forms, records, and reports required for calibration personnel at all levels are prescribed by TB 750-25.

**b.** Adjustments to be reported are designated (R) at the end of the sentence in which they appear. When adjustments are in tables, the (R) follows the designated adjustment. Report only those adjustments made and designated with (R).

**3. Calibration Description.** TI parameters and performance specifications which pertain to this calibration are listed in table 1.

Table 1. Test Instrument

Manufacturers	Models or military designators	Tables for specifications, calibration performance limits, and figures for adjustments	
		Tables	Figures
---	ME-297//U	3	1
---	TS-352()/U	4	2
Simpson	260	5	---
Simpson	260-3	6	3
Simpson	260-4	7	4
Simpson	260-5	8	5
Simpson	269	9	---
Simpson	269 Series III	10	6
Simpson	270	11	7
Triplett	310	12	---
Triplett	630	13	---
Triplett	630NA	14	8
Triplett	630PL	15	---
Triplett	666R	16	---

**SECTION II  
EQUIPMENT REQUIREMENTS**

**4. Equipment Required.** Table 2 identifies the specific equipment to be used in this calibration procedure. This equipment is issued with Secondary Transfer Calibration Standards Set AN/GSM-286, and AN/GSM-287. Alternate items may be used by the calibrating activity. The items selected must be verified to perform satisfactorily prior to use and must bear evidence of current calibration. The equipment must meet or exceed the minimum use specifications listed in table 2. The accuracies listed in table 2 provide a four-to-one ratio between the standard and TI.

**5. Accessories Required.** The accessories required for this calibration are common usage accessories issued as indicated in paragraph 4 above, and are not listed in this calibration procedure.

Table 2. Minimum Specifications of Equipment Required

Common name	Minimum use specifications <sup>1</sup>	Manufacturer and model (part number)
CALIBRATOR	Dc voltage: Range: 0 to 1100 V Accuracy: ±.375%  Dc current: Range: 50 µA to 10 A Accuracy: ±.25%  Ac voltage Range: 0 to 1100 V Frequency: 60 Hz to 100 Hz Accuracy: ±.625%	Fluke, Model 5720A (5700A/EP) (p/o MIS-35947), w/amplifier, Fluke, 5725A/AR (5725A/AR)
POWER SUPPLY	Range: 0 to 6300 V dc Accuracy: ±0.25%	Fluke, Model 410B/AT (MIS-10230) (MIS 45839)
RESISTANCE STANDARD NO. 1	Range: 0 to 1.1 MΩ Accuracy: ±0.047%	Biddle-Gray, Model 71-631 (7910328)
RESISTANCE STANDARD NO. 2	Range: 1 to 10 MΩ Accuracy: ±0.047%	Beckman, Model CR10M (8598965)
RESISTANCE STANDARD NO. 3	Range: 10 to 200 MΩ Accuracy: ±0.047%	Beckman, Model CR100M (8598966)

<sup>1</sup>The ranges and accuracies listed reflect the highest range required and the best accuracy required, respectively, in this technical bulletin.

**SECTION III  
CALIBRATION PROCESS**

**6. Preliminary Instructions**

**a.** The instructions outlined in paragraphs 6 and 7 are preparatory to the calibration process. Personnel should become familiar with the entire bulletin before beginning the calibration.

**b.** Items of equipment used in this procedure are referenced within the text by common name as listed in table 2.

## TB 9-6625-2352-35

c. Unless otherwise specified, verify the result of each test and, whenever the test requirement is not met, take corrective action before continuing with the calibration. Adjustments required to calibrate the TI are included in this procedure. Additional maintenance information is contained in the manufacturers' manuals and/or technical manuals for the TI.

d. This is a general procedure which provides instructions for the calibration of a variety of multimeters.

e. Unless otherwise specified, all controls and control settings refer to the TI.

### 7. Equipment Setup

#### WARNING

HIGH VOLTAGE is used or exposed during the performance of this calibration. DEATH ON CONTACT may result if personnel fail to observe safety precautions. REDUCE OUTPUT(S) to minimum after each step within the performance check where applicable.

a. If necessary, mechanically zero meter pointer, using adjustment screw on meter face.

b. Connect test leads to TI COM (-) and VOA (+) jacks.

### 8. Dc Voltage

#### a. Performance Check

(1) Set function switch to dc volts and range switch to first dc voltage range listed in calibration performance specifications and adjustments table for TI being calibrated.

(2) Connect TI to calibrator **OUTPUT HI** and **OUTPUT LO**, observing polarity.

(3) Set calibrator to initial output as listed in table.

(4) Rotate calibrator knob, below **EDIT FIELD** pushbutton, for the required indication on TI. If calibrator displayed output does not indicate within limits specified, and an adjustment is listed, adjust calibrator for nominal value and then perform adjustment for required indication on TI.

(5) Repeat technique of (1), (3) and (4) above for the remaining dc voltage ranges.

b. **Adjustments.** No further adjustments can be made.

### 9. Ac Voltage

#### a. Performance Check

(1) Set function switch to ac volts and range switch to first ac voltage range listed in calibration performance limits and adjustments table for TI being calibrated.

(2) Set calibrator to initial output and frequency as listed in table.

(3) Rotate calibrator knob, below **EDIT FIELD** pushbutton, for the required indication on TI. If calibrator **err** display does not indicate within limits specified, and an

adjustment is listed, adjust calibrator for nominal value and then perform adjustment for required indication on TI.

- (4) Repeat technique of (1), (2) and (3) above for the remaining ac voltage ranges.

**b. Adjustments.** No further adjustments can be made.

## 10. Resistance

### a. Performance Check

(1) Set function switch to ohms and range switch to first ohms range listed in calibration performance limits and adjustments table for TI being calibrated.

- (2) Short test leads together and adjust ohms adjust for a 0 indication on TI ohms scale.

#### NOTE

Perform (2) above for each range prior to making resistance check on the range.

#### NOTE

Connect resistance standards NO. 1, NO. 2, and NO. 3 in series, as needed, to obtain required resistance values.

- (3) Connect TI to resistance standard NO. 1.

(4) Adjust resistance standard for required indication on TI as listed in table. If resistance standard does not indicate within limits specified, and an adjustment is listed, adjust resistance standard for nominal value and perform adjustment for required indication on TI.

- (5) Repeat technique of (1), (2) and (4) above for the remaining ohms ranges.

**b. Adjustments.** No further adjustments can be made.

## 11. Dc Current

### a. Performance Check

(1) Set function switch to dc amps and range switch to the first dc current range listed in the calibration performance specifications and adjustments table for the TI being calibrated.

- (2) Set calibrator to initial output as listed in table.

(3) Rotate calibrator knob, below **EDIT FIELD** pushbutton, for the required indication on TI. If calibrator **err** display does not indicate within limits specified, and an adjustment is listed, adjust calibrator for nominal value and then perform adjustment for required indication on TI.

- (4) Repeat technique of (1) through (3) above for the remaining dc current ranges.

**b. Adjustments.** No further adjustments can be made.

#### NOTE

The sets of tables below for each instrument are setup as follows; a = specifications, b = Dc volts, c = Ac volts, d = resistance and e = Dc current.

**TB 9-6625-2352-35**

Table 3a. ME-297/U Specifications

Test instrument parameters	Performance specifications
Dc voltage	Range: 0 to 2.5, 10, 50, 250, 500, 1000 V at 1000 Ω per V 0 to 5000 V at 1000 Ω per V Accuracy: ±3% FS from 0 to 500 V at 1000 and 20,000 Ω / V ±3% FS at 1000 V at 1000 Ω / V ±4% FS at 1000 V at 20,000 Ω / V ±6% FS at 5000 V at 20,000 Ω / V and 1 kΩ
Ac voltage	Range: 0 to 0.5, 2.5, 10, 50 250, 500, and 1000 V at 1000 or 20,000 Ω per V 0 to 5000 V at 1000 Ω and 20,000 Ω per V Accuracy: ±4% FS from 0 to 500 V ±5% FS at 1000 V ±7% FS at 5000 V
Resistance	Range: 0 to 10 MΩ in 5 ranges Accuracy: ±3% FS of meter arc length
Dc current	Range: 0 to 0.25, 1.0, 2.5, 50, 100, 500, and 2500 mA 0 to 10 A Accuracy: ±3% of FS

Table 3b. ME-297/U Dc Volts

Calibration Performance Limits and Adjustments					
Dc Voltage					
Test instrument		Calibrator output			Test instrument
Dc volts range	Indication (V)	Initial output (V)	Limits		Adjustments
			Min	Max	
2.5 <sup>1</sup>	2.5	2.5	2.425	2.575	None
10	10	10	9.7	10.3	
10	7	7	6.7	7.3	
10	3	3	2.7	3.3	
50	50	50	48.5	51.5	
250	250	250	242.5	257.5	
500	500	500	485	515	
1000 <sup>2</sup>	1000	1000	970	1030	
5000 <sup>3</sup>	5000 (700)	5000 (700)	4700 (400)	5300 (1000)	
5000 <sup>4</sup>	5000 (700)	5000 (700)	4700 (400)	5300 (1000)	
1000	1000	1000	960	1040	
500 <sup>5</sup>	500	500	485	515	
250	250	250	242.5	257.5	
50	50	50	48.5	51.5	
10	10	10	9.7	10.3	
2.5	2.5	2.5	2.425	2.575	
.5	.5	.5	.485	.515	

<sup>1</sup> Function switch to **DC VOLTS 1 KΩ**.

<sup>2</sup> Reduce output to minimum and move positive lead from TI **V-Ω-A** input to TI **AC/DC 1000 Ω/V 1000 V** input.

<sup>3</sup> Reduce output to minimum. Replace calibrator with power supply and move positive lead to TI **V-Ω-A** input to TI **AC/DC 1000 Ω/V 5000 V** input. Calibrate at 700 V if power supply is not available.

<sup>4</sup> Reduce output to minimum and set TI function switch to **DC VOLTS 20 KΩ** and move positive lead from TI **V-Ω-A** input to TI **AC/DC 20000 Ω/V 5000 V** input. After 5000V check is complete, replace power supply with calibrator and move positive lead to TI **AC/DC 20000 Ω/V 1000 V** input.

<sup>5</sup> Reduce output to minimum and move positive lead from TI **AC/DC 20000 Ω/V 1000 V** input to TI **V-Ω-A** input.

Table 3c. ME-297/U Ac Volts  
Calibration Performance Limits and Adjustments  
Ac Voltage

Test instrument		Calibrator			Test instrument
Ac volts range	Indication (V)	Initial output (V)	Frequency (Hz)	err indication ± (%)	Adjustments (fig. 1)
50	50	50	400	4	R42 (R)
2.5	2.5	2.5	400	4	R41 <sup>1</sup> (R)
10	10	10	400	4	----
250	250	250	400	4	----
500	500	500	400	4	----
1000 <sup>2</sup>	1000	1000	400	5	----
5000 <sup>3</sup>	700	700	400	50	----

<sup>1</sup> Recheck 50 V range and, if necessary, readjust R42 (fig. 1) and R41 (fig. 1) for best in-tolerance condition.

<sup>2</sup> Reduce output to minimum and move positive lead from TI **V-Ω-A** input to TI **AC/DC 1000 Ω/V 1000 V** input.

<sup>3</sup> Reduce output to minimum and move positive lead to TI **AC/DC 1000 Ω/V 5000 V** input.

Table 3d. ME-297/U Resistance  
Calibration Performance Limits and Adjustments  
Resistance

Test instrument		Resistance standard indications (Ω)		Test instrument
Resistance range <sup>1</sup>	Indications ohms scale (Ω)	Min	Max	Adjustments
X1	0 <sup>2</sup>	---	---	Short leads, adjust <b>OHMS ZERO</b> for <b>0</b> indication. Open leads, adjust <b>OHMS INF</b> for ∞ indication.
X1	25	22.0	28.0	
X10	25	220	280	
X100	25	2200	2800	
X1000	25	22,000	28,000	
X10,000	25	220,000	280,000	

<sup>1</sup> Adjust **OHMS ZERO** and **OHMS INF** controls for each range.

<sup>2</sup> If **0** indication cannot be obtained, set **OHMS ZERO** control to mid-position, short leads, and adjust R36 (fig.1) for **0** indication.

Table 3e. ME-297/U Dc Current  
Calibration Performance Limits and Adjustments  
Dc Current

Test instrument		Calibrator		Test instrument
Dc mA range	Indication (mA)	Initial output (mA)	err indication ± (%)	Adjustments (fig. 1)
.25	.25	.25	3	R50 (R)
2.5	2.5	2.5	3	----
10	10	10	3	----
50	50	50	3	----
100	100	100	3	----
500	500	500	3	----
2500	2500	2500	3	----
10 A <sup>1</sup>	10 A	10 A	3	----

<sup>1</sup> Reduce output to minimum and connect TI positive lead to **+10A** input.

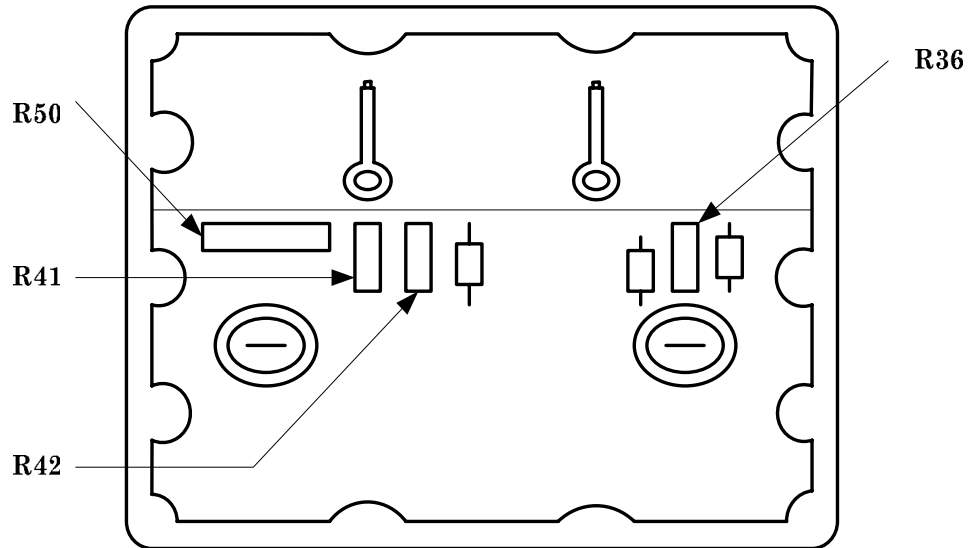

Figure 1. ME-297/U.

Table 4a. TS-352/U Specifications

Test instrument parameters	Performance specifications
Dc voltage	Range: 0 to 1000 V at 1000 $\Omega$ per V Accuracy: $\pm 3\%$ of FS Range: 0 to 1000 V at 20,000 $\Omega$ per V Accuracy: $\pm 4\%$ of FS Range: 0 to 5000 V at 20,000 $\Omega$ per V Accuracy: $\pm 6\%$ of FS
Ac voltage	Range: 0 to 500 V at 1000 $\Omega$ per V Accuracy: $\pm 4\%$ at 400 Hz, $\pm 7\%$ at 10 kHz of FS Range: 1000 V at 1000 $\Omega$ per V Accuracy: $\pm 5\%$ at 400 Hz, $\pm 8\%$ at 10 kHz of FS
Resistance	Range: 0 to 10,000,000 $\Omega$ Accuracy: $\pm 3\%$ (percent values are in terms of meter arc length, not of $\Omega$ indicated by meter)
Dc current	Range: 0 to 10 A Accuracy: $\pm 3\%$ of FS

Table 4b. TS-352/U Dc Volts

Calibration Performance Limits and Adjustments					
Dc Voltage					
Test instrument		Calibrator output			Test instrument
Dc volts range	Indication (V)	Initial output (V)	Limits		Adjustments
			Min	Max	
2.5 <sup>1</sup>	2.5	2.5	2.40	2.60	None
10	10	10	9.60	10.40	
10	6	6	5.60	6.40	
10	2	2	1.60	2.40	
50	50	50	48.0	52.0	
250	250	250	240.0	260.0	
500	500	500	480.0	520.0	

See footnote at the end of the table.



Table 4b. TS-352/U Dc Volts Continued  
Calibration Performance Limits and Adjustments  
Dc Voltage

Test instrument		Calibrator output			Test instrument
Dc volts range	Indication (V)	Initial output (V)	Limits		Adjustments
			Min	Max	
1000	1000	1000	960	1040	None
5000 <sup>2</sup>	5000 (700)	5000 (700)	4700 (400)	5300 (1000)	
1000 <sup>3</sup>	1000	1000	970	1030	
500	500	500	485	515.0	
250	250	250	242.5	257.5	
50	50	50	48.5	51.5	
10	10	10	9.7	10.30	
2.5	2.5	2.5	2.425	2.575	

<sup>1</sup> Set function switch to **20000 Ω/VDC**.

<sup>2</sup> Replace calibrator with power supply. Connect lead between TI **20000 OHMS PER VOLT DC 2.5 V** input and TI **CONNECT TO 2.5 V JACK**. Calibrate at 700 V if power supply is not available.

<sup>3</sup> Set function switch to **1000 Ω/VDC**. Replace power supply with calibrator and remove lead connected in <sup>2</sup> above.

Table 4c. TS-352/U Ac Volts  
Calibration Performance Limits and Adjustments  
Ac Voltage

Test instrument		Calibrator			Test instrument
Ac volts range	Indication (V)	Initial output (V)	Frequency (Hz)	err indication ± (%)	Adjustments (fig. 2)
10	10	10	400	4	----
50	50	50	400	4	----
250	250	250	400	4	----
500	500	500	400	4	----
1000 <sup>1</sup>	1000	1000	400	5	----

<sup>1</sup> Reduce output to minimum and move positive lead from TI + input to TI **1000 V AC** input. After 1000 V check is complete, reduce output to minimum and move positive lead back to TI + input.

Table 4d. TS-352/U Resistance  
Calibration Performance Limits and Adjustments  
Resistance

Test instrument		Resistance standard indications (Ω)		Test instrument
Resistance range <sup>1</sup>	Indications ohms scale (Ω)	Min	Max	Adjustments
RX10	250	220	280	
RX100	2.5 k	2200	2800	
RX1K	25 k	22,000	28,000	
RX10K	250 k	220,000	280,000	

<sup>1</sup> Short leads and adjust **OHMS ZERO ADJ** for 0 indication on ohms scale. Repeat for each range.

Table 4e. TS-352/U Dc Current  
Calibration Performance Limits and Adjustments  
Dc Current

Test instrument		Calibrator		Test instrument
Dc current range	Indication (A)	Initial output (A)	err indication ± (%)	Adjustments
250 μA	250 μA	250 μA	3	None
2.5 mA	2.5 mA	2.5 mA	3	
10 mA	10 mA	10 mA	3	
50 mA	50 mA	50 mA	3	
100 mA	100 mA	100 mA	3	
500 mA	500 mA	500 mA	3	
2.5 A	2.5 A	2.5 A	3	
10 A <sup>1</sup>	10 A	10 A	3	

<sup>1</sup> Connect positive lead to TI +10 AMPS ONLY input.

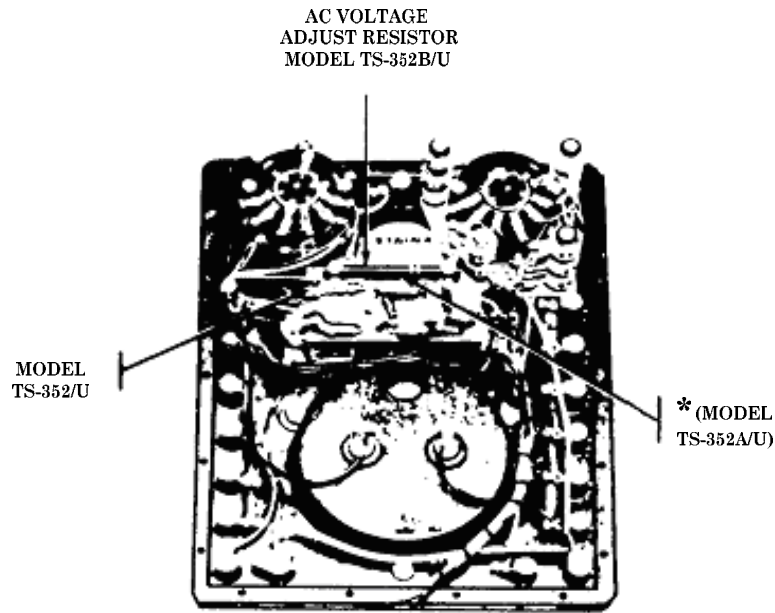

\* LOCATED AT BOTTOM  
OF A101

Figure 2. TS-352()/U.

Table 5a. Simpson, Model 260 Specifications

Test instrument parameter	Performance specification
Dc voltage	Range: 0 to 5000 V Accuracy: ±3% of FS
Ac voltage	Range: 0 to 5000 V Accuracy: ±5% of FS
Resistance	Range: 0 to 20 MΩ Accuracy: ±3° of arc
Dc current	Range: 0 to 10 A Accuracy: ±3% of FS

Table 5b. Simpson, Model 260 Dc Voltage  
Calibration Performance Limits and Adjustments  
Dc Voltage

Test instrument <sup>1</sup>		Calibrator output			Test instrument
Dc volts range	Indication (V)	Initial output (V)	Limits		Adjustments
			Min	Max	
2.5	2.5	2.5	2.425	2.575	None
10	10	10	9.7	10.3	
50	50	50	48.5	51.5	
250	250	250	242.5	257.5	
1000	1000	1000	970	1030	
5000 <sup>2</sup>	5000 (900)	5000 (900)	4850 (750)	5150 (1050)	

<sup>1</sup>TI must be calibrated in horizontal position.

<sup>2</sup>Replace calibrator with power supply. Move positive lead to TI **D.C. 5000 V** input. Calibrate at 900 V if power supply not available. After 5000 V test, replace power supply with calibrator and move positive lead to TI + input.

Table 5c. Simpson, Model 260 Ac Voltage  
Calibration Performance Limits and Adjustments  
Ac Voltage

Test instrument <sup>1</sup>		Calibrator			Test instrument
Ac volts range	Indication (V)	Initial output (V)	Frequency (Hz)	err indication ± (%)	Adjustments
10	10	10	60	5	
50	50	50	60	5	
250	250	250	60	5	
1000	1000	1000	60	5	
5000 <sup>2</sup>	800	800	60	31.25	

<sup>1</sup>TI must be calibrated in horizontal position.

<sup>2</sup>Reduce output to minimum and move positive lead from TI + input to TI **A.C. 5000 V** input. After 5000V check is complete, reduce output to minimum and move positive lead to TI + input.

Table 5d. Simpson, Model 260 Resistance  
Calibration Performance Limits and Adjustments  
Resistance

Test instrument <sup>1</sup>		Resistance standard indications (Ω)		Test instrument
Resistance range <sup>2</sup>	Indications Ohms scale (Ω)	Min	Max	Adjustments
RX100	12	1050	1370	
RX10,000	12	105,000	137,000	

<sup>1</sup>TI must be calibrated in horizontal position.

<sup>2</sup>Short leads and adjust **ZERO OHMS** for a 0 indication on ohms scale. Repeat for each range.

**TB 9-6625-2352-35**

Table 5e. Simpson, Model 260 Dc Current  
Calibration Performance Limits and Adjustments  
Dc Current

Test instrument <sup>1</sup>		Calibrator		Test instrument
Dc current range	Indication (A)	Initial output (A)	err indication ± (%)	Adjustments
50 μA <sup>2</sup>	50 μA	50 μA	3	None
100 μA	100 μA	100 μA	3	
1 mA	1 mA	1 mA	3	
1 mA	.6 mA	.6 mA	5	
1 mA	.2 mA	.2 mA	15	
10 mA	10 mA	10 mA	3	
100 mA	100 mA	100 mA	3	
500 mA	500 mA	500 mA	3	
10 A <sup>3</sup>	10 A	10 A	3	

<sup>1</sup>TI must be calibrated in horizontal position.

<sup>2</sup> Connect positive lead to TI **+50 μA** input. After 50 μA check is complete, reduce output to minimum and move positive lead to TI + input.

<sup>3</sup> Reduce output to minimum and connect TI negative lead to **-10A** input and connect TI positive lead to **+10A** input.

Table 6a. Simpson, Model 260-3 Specifications

Test instrument parameter	Performance specification
Dc voltage	Range: 0 to 5000 V Accuracy: ±3% of FS
Ac voltage	Range: 0 to 5000 V Accuracy: ±3% of FS
Resistance	Range: 0 to 20 MΩ Accuracy: ±3° of arc
Dc current	Range: 0 to 10 A Accuracy: ±3% of FS

Table 6b. Simpson, Model 260-3 Dc Voltage  
Calibration Performance Limits and Adjustments  
Dc Voltage

Test instrument <sup>1</sup>		Calibrator output		Test instrument	
Dc volts range	Indication (V)	Initial output (V)	Limits		Adjustments
			Min	Max	
2.5	2.5	2.5	2.425	2.575	None
10	10	10	9.7	10.3	
50	50	50	48.5	51.5	
250	250	250	242.5	257.5	
1000	1000	1000	970	1030	
5000 <sup>2</sup>	5000 (900)	5000 (900)	4850 (750)	5150 (1050)	

<sup>1</sup>TI must be calibrated in horizontal position.

<sup>2</sup> Replace calibrator with power supply. Move positive lead to TI **D.C. 5000 V** input. Calibrate at 900 V if power supply not available. After 5000 V check is complete, reduce output to minimum and move positive lead to TI + input.

Table 6c. Simpson, Model 260-3 Ac Voltage  
Calibration Performance Limits and Adjustments  
Ac Voltage

Test instrument <sup>1</sup>		Calibrator			Test instrument
Ac volts range	Indication (V)	Initial output (V)	Frequency (Hz)	err indication ± (%)	Adjustments (fig. 3)
250	250	250	60	3	R31 (R)
2.5	2.5	2.5	60	3	R28 <sup>2</sup> (R)
10	10	10	60	3	----
50	50	50	60	3	----
1000	1000	1000	60	3	----
5000 <sup>3</sup>	900	900	60	16.67	----

<sup>1</sup>TI must be calibrated in horizontal position.

<sup>2</sup>Recheck 250 V range and, if necessary, readjust R31 (fig. 3) and R28 (fig. 3) for best in-tolerance condition.

<sup>3</sup> Reduce output to minimum and move positive lead from TI + input to TI **A.C. 5000 V** input. After 5000 V check is complete, reduce output to minimum and move positive lead to TI + input.

Table 6d. Simpson, Model 260-3 Resistance  
Calibration Performance Limits and Adjustments  
Resistance

Test instrument <sup>1</sup>		Resistance standard indications (Ω)		Test instrument
Resistance range <sup>2</sup>	Indications ohms scale (Ω)	Min	Max	Adjustments
RX1	12	10.5	13.7	None
RX100	12	1050	1370	
RX10,000	12	105,000	137,000	

<sup>1</sup>TI must be calibrated in horizontal position.

<sup>2</sup> Short leads and adjust **ZERO OHMS** for a 0 indication on ohms scale. Repeat for each range.

Table 6e. Simpson, Model 260-3 Dc Current  
Calibration Performance Limits and Adjustments  
Dc Current

Test instrument <sup>1</sup>		Calibrator		Test instrument
Dc current range	Indication (A)	Initial output (A)	err indication ± (%)	Adjustments (fig. 3)
50 μA <sup>2</sup>	50 μA	50 μA	3	----
100 μA	100 μA	100 μA	3	----
1 mA	1 mA	1 mA	3	R27 (R)
1 mA	.6 mA	.6 mA	5	----
1 mA	.2 mA	.2 mA	15	----
10 mA	10 mA	10 mA	3	----
100 mA	100 mA	100 mA	3	----
500 mA	500 mA	500 mA	3	--
10 A <sup>3</sup>	10 A	10 A	3	R22 (R)

<sup>1</sup>TI must be calibrated in horizontal position.

<sup>2</sup> Connect positive lead to TI **+50 μA** input. After 50 μA check is complete, reduce output to minimum and move positive lead to TI + input.

<sup>3</sup> Reduce output to minimum and connect TI negative lead to **-10A** input and connect TI positive lead to **+10A** input.

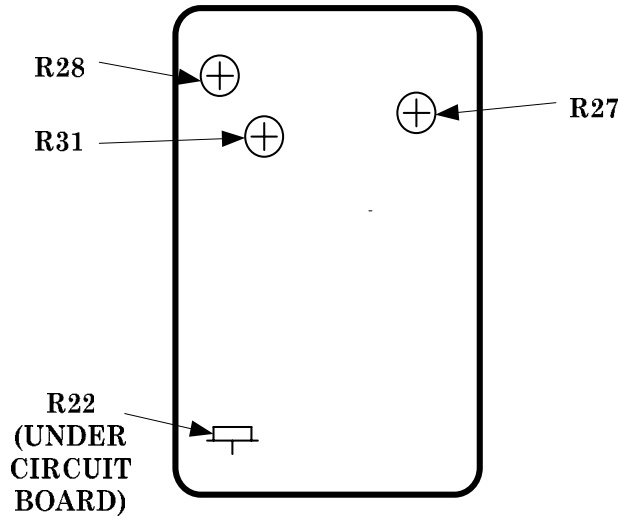

Figure 3. Simpson, Model 260-3.

Table 7a. Simpson, Model 260-4 Specifications

Test instrument parameter	Performance specification
Dc voltage	Range: 0 to 5000 V Accuracy: $\pm 2\%$ of FS
Ac voltage	Range: 0 to 5000 V Accuracy: $\pm 3\%$ of FS
Resistance	Range: 0 to 20 M $\Omega$ Accuracy: $\pm 3^\circ$ of arc
Dc current	Range: 0 to 10 A Accuracy: $\pm 2\%$ of FS

Table 7b. Simpson, Model 260-4 Dc Voltage  
Calibration Performance Limits and Adjustments  
Dc Voltage

Test instrument <sup>1</sup>		Calibrator output			Test instrument
Dc volts range	Indication	Initial output	Limits		Adjustments
			Min	Max	
250 <sup>2</sup>	250	250 mV	245 mV	255 mV	None
2.5	2.5	2.5 V	2.45 V	2.55 V	
10	10	10 V	9.8 V	10.2 V	
50	50	50 V	49 V	51 V	
250	250	250 V	245 V	255 V	
1000	1000	1000 V	980 V	1020 V	
5000 <sup>3</sup>	5000 (900)	5000 (900) V	4900 (800) V	5100 (1000) V	

<sup>1</sup> TI must be calibrated in horizontal position.

<sup>2</sup> Connect TI positive lead to TI **+50  $\mu$ A/250mV** input. After 250 mV check, move TI positive lead to TI **+** input.

<sup>3</sup> Replace calibrator with power supply. Move positive lead to TI **D.C. 5000 V** input. Calibrate at 900 V if power supply not available. After 5000 V check is complete, reduce output to minimum and move positive lead to TI **+** input.

Table 7c. Simpson, Model 260-4 Ac Voltage  
Calibration Performance Limits and Adjustments  
Ac Voltage

Test instrument <sup>1</sup>		Calibrator			Test instrument
Ac volts range	Indication (V)	Initial output (V)	Frequency (Hz)	err indication ± (%)	Adjustments (fig. 4)
250	250	250	60	3	R31 (R)
2.5	2.5	2.5	60	3	R28 (R)
10	10	10	60	3	----
50	50	50	60	3	----
1000	1000	1000	60	3	----
5000 <sup>2</sup>	900	900	60	16.67	----

<sup>1</sup>TI must be calibrated in horizontal position.

<sup>2</sup> Reduce output to minimum and move positive lead from TI + input to TI A.C. 5000 V input. After 5000 V check is complete, reduce output to minimum and move positive lead to TI + input.

Table 7d. Simpson, Model 260-4 Resistance  
Calibration Performance Limits and Adjustments  
Resistance

Test instrument <sup>1</sup>		Resistance standard indications (Ω)		Test instrument
Resistance range <sup>2</sup>	Indications ohms scale (Ω)	Min	Max	Adjustments
RX1	12	10.5	13.7	None
RX100	12	1050	1370	
RX10,000	12	105,000	137,000	

<sup>1</sup>TI must be calibrated in horizontal position.

<sup>2</sup> Short leads and adjust **ZERO OHMS** for **0** indication on ohms scale. Repeat for each range.

Table 7e. Simpson, Model 260-4 Dc Current  
Calibration Performance Limits and Adjustments  
Dc Current

Test instrument <sup>1</sup>		Calibrator		Test instrument
Dc current range	Indication (A)	Initial output (A)	err indication ± (%)	Adjustments (fig. 4)
50 μA <sup>2</sup>	50 μA	50 μA	2	R32 (R)
1 mA	1 mA	1 mA	2	R27 (R)
10 mA	10 mA	10 mA	2	----
10 mA	6 mA	6 mA	3.33	----
10 mA	2 mA	2 mA	10	----
100 mA	100 mA	100 mA	2	----
500 mA	500 mA	500 mA	2	----
10 A <sup>3</sup>	10 A	10 A	2	R22 (R)

<sup>1</sup>TI must be calibrated in horizontal position.

<sup>2</sup> Connect positive lead to TI +50 μA/250 mV input. After 50 μA check is complete, reduce output to minimum and move positive lead to TI + input.

<sup>3</sup> Reduce output to minimum and connect TI negative lead to -10A input and connect TI positive lead to +10A input.

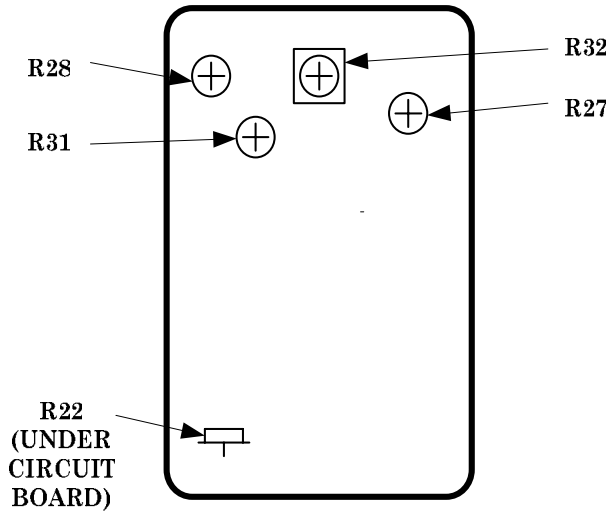

Figure 4. Simpson, Model 260-4.

Table 8a. Simpson, Model 260-5 Specifications

Test instrument parameter	Performance specification
Dc voltage	Range: 0 to 5000 V Accuracy: ±2% of FS 0 to 1000 V range ±3% of FS 5000 V range
Ac voltage	Range: 0 to 1000 V Accuracy: ±3% of FS 0 to 1000 V range ±4% of FS 5000 V range
Resistance	Range: 0 to 20 MΩ Accuracy: ±2.5° of arc for RX1 range, ±2° of arc for all other ranges
Dc current	Range: 0 to 10A Accuracy: ±1.5% of FS for 50 μA range, ±2% of FS for all other ranges

Table 8b. Simpson, Model 260-5 Dc Voltage Calibration Performance Limits and Adjustments  
Dc Voltage

Test instrument <sup>1</sup>		Calibrator output			Test instrument
Dc volts range	Indication	Initial output	Limits		Adjustments
			Min	Max	
250 <sup>2</sup>	250	250 mV	245 mV	255 mV	None
2.5	2.5	2.5 V	2.45 V	2.55 V	
10	10	10 V	9.8 V	10.2 V	
50	50	50 V	49 V	51 V	
250	250	250 V	245 V	255 V	
1000	1000	1000 V	980 V	1020 V	
5000 <sup>3</sup>	5000 (900)	5000 (900) V	4850 (750) V	5150 (1050) V	

<sup>1</sup> TI must be calibrated in horizontal position.

<sup>2</sup> Connect TI positive lead to TI +50 μA/250 mV input. After 250 mV check, move TI positive lead to TI + input.

<sup>3</sup> Replace calibrator with power supply. Move positive lead to TI D.C. 5000 V input. Calibrate at 900 V if power supply not available. After 5000 V check is complete, reduce output to minimum, replace power supply with calibrator and move positive lead to TI + input.



Table 8c. Simpson, Model 260-5 Ac Voltage  
Calibration Performance Limits and Adjustments  
Ac Voltage

Test instrument <sup>1</sup>		Calibrator			Test instrument
Ac volts range	Indication (V)	Initial output (V)	Frequency (Hz)	err indication ± (%)	Adjustments (fig. 5)
250	250	250	60	3	R31 (R)
2.5	2.5	2.5	60	3	R28 (R)
10	10	10	60	3	----
50	50	50	60	3	----
1000	1000	1000	60	3	----
5000 <sup>2</sup>	900	900	60	22.2	----

<sup>1</sup>TI must be calibrated in horizontal position.

<sup>2</sup> Reduce output to minimum and move positive lead from TI + input to TI A.C. 5000 V input. After 5000 V check is complete, reduce output to minimum and move positive lead to TI + input.

Table 8d. Simpson, Model 260-5 Resistance  
Calibration Performance Limits and Adjustments  
Resistance

Test instrument <sup>1</sup>		Resistance standard indications (Ω)		Test instrument
Resistance range <sup>2</sup>	Indications ohms scale (Ω)	Min	Max	Adjustments
RX1	12	10.7	13.5	----
RX100	12	1110	1300	----
RX10K	12	111,000	130,000	----

<sup>1</sup>TI must be calibrated in horizontal position.

<sup>2</sup> Short leads and adjust **OHMS ADJ** control for a **0** indication on ohms scale. Repeat for each range.

Table 8e. Simpson, Model 260-5 Dc Current  
Calibration Performance Limits and Adjustments  
Dc Current

Test instrument <sup>1</sup>		Calibrator		Test instrument
Dc current range	Indication (A)	Initial output (A)	err indication ± (%)	Adjustments (fig. 5)
50 μA <sup>2</sup>	50 μA	50 μA	1.5	R32 (R)
1 mA	1 mA	1 mA	2	R27 (R)
10 mA	10 mA	10 mA	2	----
10 mA	6 mA	6 mA	3.33	----
10 mA	2 mA	2 mA	10	----
100 mA	100 mA	100 mA	2	----
500 mA	500 mA	500 mA	2	----
10 A <sup>3</sup>	10 A	10 A	2	R22 (R)

<sup>1</sup>TI must be calibrated in horizontal position.

<sup>2</sup> Connect positive lead to TI +50 μA/250 mV input. After 50 μA check is complete, reduce output to minimum and move positive lead to TI + input.

<sup>3</sup> Reduce output to minimum and connect TI negative lead to -10A input and connect TI positive lead to +10A input.

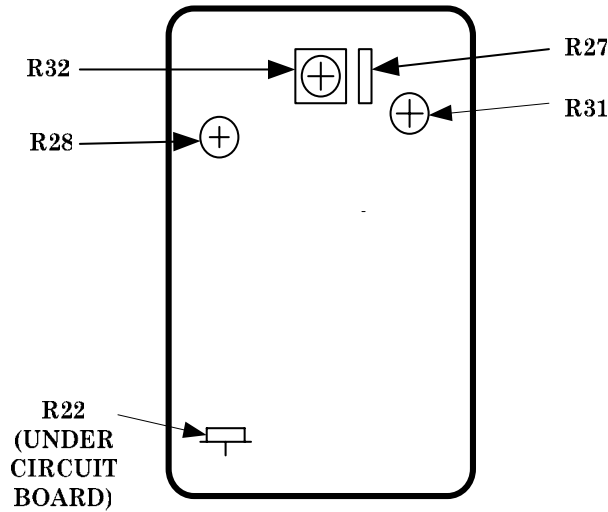

Figure 5. Simpson, Model 260-5.

Table 9a. Simpson, Model 269 Specifications

Test instrument parameter	Performance specification
Dc voltage	Range: 0 to 4000 V Accuracy: $\pm 3\%$ of FS
Ac voltage	Range: 0 to 800 V Accuracy: $\pm 5\%$ of FS
Resistance	Range: 0 to 200 M $\Omega$ Accuracy: $\pm 3^\circ$ of arc
Dc current	Range: 0 to 16A Accuracy: $\pm 3\%$ of FS

Table 9b. Simpson, Model 269 Dc Voltage  
Calibration Performance Limits and Adjustments  
Dc Voltage

Test instrument		Calibrator output			Test instrument
Dc volts range	Indication (V)	Initial output (V)	Limits		Adjustments
			Min	Max	
1.6	1.6	1.6	1.552	1.648	None
8	8	8	7.76	8.24	
40	40	40	38.8	41.2	
160	160	160	155.2	164.8	
400	400	400	388	412	
1600 <sup>1, 2</sup>	1600 (900)	1600 (900)	1552 (780)	1648 (1020)	
4000 <sup>2, 3, 4</sup>	4000 (900)	4000 (900)	3880 (780)	4120 (1020)	

<sup>1</sup> Replace calibrator with power supply.

<sup>2</sup> Calibrate at 900 V if power supply is not available.

<sup>3</sup> Perform only if 4000 V probe is available.

<sup>4</sup> Replace power supply with calibrator.

Table 9c. Simpson, Model 269 Ac Voltage  
Calibration Performance Limits and Adjustments  
Ac Voltage

Test instrument		Calibrator			Test instrument
Ac volts range	Indication (V)	Initial output (V)	Frequency (Hz)	err indication ± (%)	Adjustments
3	3	3	60	3	None
8	8	8	60	3	
40	40	40	60	3	
160	160	160	60	3	
800	800	800	60	3	

Table 9d. Simpson, Model 269 Resistance  
Calibration Performance Limits and Adjustments  
Resistance

Test instrument		Resistance standard indications (Ω)		Test instrument
Resistance range <sup>1</sup>	Indications ohms scale (Ω)	Min	Max	Adjustments
RX1	18	15.8	20.4	None
RX10	18	158	204	
RX100	18	1.58 k	2.04 k	
RX1K	18	15.8 k	20.4 k	
RX10K	18	158 k	204 k	
RX100K	6	495 k	715 k	

<sup>1</sup> Short leads and adjust **ZERO OHMS** for **0** indication on ohms scale. Repeat for each range.

Table 9e. Simpson, Model 269 Dc Current  
Calibration Performance Limits and Adjustments  
Dc Current

Test instrument		Calibrator		Test instrument
Dc current range	Indication	Initial output	err indication ± (%)	Adjustments
16 μA	16 μA	16 μA	3	None
16 μA	10 μA	10 μA	4.8	
16 μA	4 μA	4 μA	12	
160 μA	160 μA	160 μA	3	
1.6 mA	1.6 mA	1.6 mA	3	
16 mA	16 mA	16 mA	3	
160 mA	160 mA	160 mA	3	
1.6 A	1.6 A	1.6 A	3	
16 A	9 A	9 A	3	

Table 10a. Simpson, Model 269 Series III Specifications

Test instrument parameter	Performance specification
Dc voltage	Range: 0 to 4000 V Accuracy: ±1.5% of FS, ±3.5% of FS on 4000 V range
Ac voltage	Range: 0 to 800 V Accuracy: ±2.5% of FS
Resistance	Range: 0 to 200 MΩ Accuracy: ±2° of arc
Dc current	Range: 0 to 8A Accuracy: ±1.5% of FS

Table 10b. Simpson, Model 269 Series III Dc Voltage  
Calibration Performance Limits and Adjustments  
Dc Voltage

Test instrument		Calibrator output			Test instrument
Dc volts range	Indication (V)	Initial output (V)	Limits		Adjustments
			Min	Max	
.8	.8	.8	0.788	0.812	None
1.6	1.6	1.6	1.576	1.624	
8	8	8	7.88	8.12	
40	40	40	39.4	40.6	
160	160	160	157.6	162.4	
400	400	400	394	406	
800	800	800	788	812	
1600 <sup>1, 2</sup>	1600 (900)	1600 (900)	1576 (876)	1624 (924)	
4000 <sup>2, 3, 4</sup>	4000 (900)	4000 (900)	3860 (760)	4140 (1040)	

<sup>1</sup> Replace calibrator with power supply.  
<sup>2</sup> Calibrate at 900 V if power supply is not available.  
<sup>3</sup> Perform only if 4000 V probe is available.  
<sup>4</sup> Replace power supply with calibrator.

Table 10c. Simpson, Model 269 Series III Ac Voltage  
Calibration Performance Limits and Adjustments  
Ac Voltage

Test instrument		Calibrator			Test instrument
Ac volts range	Indication (V)	Initial output (V)	Frequency (Hz)	err indication ± (%)	Adjustments (fig. 6)
8	8	8	60	2.5	----
40	40	40	60	2.5	----
160	160	160	60	2.5	R37 (R)
400	400	400	60	2.5	----
800	800	800	60	2.5	----

Table 10d. Simpson, Model 269 Series III Resistance  
Calibration Performance Limits and Adjustments  
Resistance

Test instrument		Resistance standard indications (Ω)		Test instrument
Resistance range <sup>1</sup>	Indications ohms scale (Ω)	Min	Max	Adjustments
RX10	12	106	134	
RX100	12	1.06 k	1.34 k	
RX1K	12	10.6 k	13.4 k	
RX10K	12	106 k	134 k	
RX100K	4	340 k	460 k	

<sup>1</sup> Short leads and adjust **ZERO OHMS** for a 0 indication on ohms scale. Repeat for each range.

Table 10e. Simpson, Model 269 Series III Dc Current  
Calibration Performance Limits and Adjustments  
Dc Current

Test instrument		Calibrator			Test instrument
Dc current range	Indication (A)	Initial output (A)	err indication ± (%)	Adjustments (fig. 6)	
16 μA	16 μA	16 μA	1.5	R40 (R)	
16 μA	10 μA	10 μA	2.4	----	
16 μA	4 μA	4 μA	6.0	----	
160 μA	160 μA	160 μA	1.5	----	
1.6 mA	1.6 mA	1.6 mA	1.5	----	
16 mA	16 mA	16 mA	1.5	----	
160 mA	160 mA	160 mA	1.5	----	
1.6 A	1.6 A	1.6 A	1.5	R1 (R)	
8 A	8 A	8 A	1.5	R35 (R)	

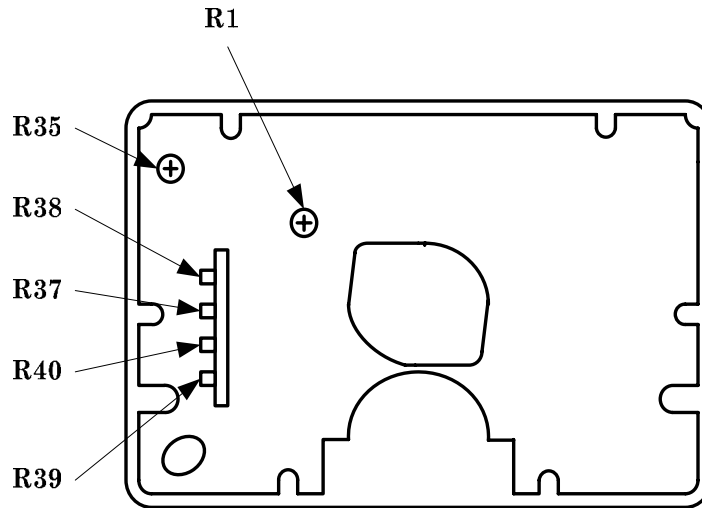

Figure 6. Simpson, Model 269 series III.

Table 11a. Simpson, Model 270 Specifications

Test instrument parameter	Performance specification
Dc voltage	Range: 0 to 1000 V Accuracy: ±2% of FS Range: 0 to 5000 V Accuracy: ±3% of FS
Ac voltage	Range: 0 to 1000 V Accuracy: ±3% of FS Range: 0 to 5000 V Accuracy: ±4% of FS
Resistance	Range: 0 to 20 MΩ Accuracy: ±2° of arc
Dc current	Range: 0 to 10A Accuracy: ±2% of FS

**TB 9-6625-2352-35**

Table 11b. Simpson, Model 270 Dc Voltage  
Calibration Performance Limits and Adjustments  
Dc Voltage

Test instrument <sup>1</sup>		Calibrator output			Test instrument
Dc volts range	Indication (V)	Initial output (V)	Limits		Adjustments
			Min	Max	
2.5	2.5	2.5	2.45	2.55	None
10	10	10	9.80	10.2	
50	50	50	49	51	
250	250	250	245	255	
1000	1000	1000	970	1030	
5000 <sup>2</sup>	5000 (900)	5000 (900)	4850 (750)	5150 (1050)	

<sup>1</sup>TI must be calibrated in horizontal position.

<sup>2</sup> Replace calibrator with power supply. Move positive lead to TI **D.C. 5000 V** input. Calibrate at 900 V if power supply not available. After 5000 V check is complete, reduce output to minimum replace power supply with calibrator and move positive lead to TI + input.

Table 11c. Simpson, Model 270 Ac voltage  
Calibration Performance Limits and Adjustments  
Ac voltage

Test instrument <sup>1</sup>		Calibrator			Test instrument
Ac volts range	Indication (V)	Initial output (V)	Frequency (Hz)	err indication ± (%)	Adjustments (Fig. 7)
2.5	2.5	2.5	60	3	R28 (R)
10	10	10	60	3	----
50	50	50	60	3	----
1000	1000	1000	60	3	----
5000 <sup>2</sup>	900	900	60	22.2	----

<sup>1</sup>TI must be calibrated in horizontal position.

<sup>2</sup> Reduce output to minimum and move positive lead from TI + input to TI **5000 V DC/AC** input. After 5000 V check is complete, reduce output to minimum and move positive lead to TI + input.

Table 11d. Simpson, Model 270 Resistance  
Calibration Performance Limits and Adjustments  
Resistance

Test instrument <sup>1</sup>		Resistance standard indications (Ω)		Test instrument
Resistance range <sup>2</sup>	Indications ohms scale (Ω)	Min	Max	Adjustments
RX100	12	1110	1300	
RX10,000	12	111,000	130,000	

<sup>1</sup>TI must be calibrated in horizontal position.

<sup>2</sup> Short leads and adjust **OHMS ADJ** for a **0** indication on ohms scale. Repeat for each range.

Table 11e. Simpson, Model 270 Dc Current  
Calibration Performance Limits and Adjustments  
Dc Current

Test instrument <sup>1</sup>		Calibrator		Test instrument
Dc current range	Indication (A)	Initial output (A)	err indication ± (%)	Adjustments (fig. 7)
50 μA <sup>2</sup>	50 μA	50 μA	2	----
1 mA	1 mA	1 mA	2	R27 (R)
10 mA	10 mA	10 mA	2	----
10 mA	6 mA	6 mA	3.33	----
10 mA	2 mA	2 mA	10	----
100 mA	100 mA	100 mA	2	----
500 mA	500 mA	500 mA	2	----
10 A <sup>3</sup>	10 A	10 A	2	R22 (R)

<sup>1</sup> TI must be calibrated in horizontal position.

<sup>2</sup> Connect positive lead to TI +50 μA input. After 50 μA check is complete, reduce output to minimum and move positive lead to TI + input.

<sup>3</sup> Reduce output to minimum and connect TI negative lead to -10A input and connect TI positive lead to +10A input.

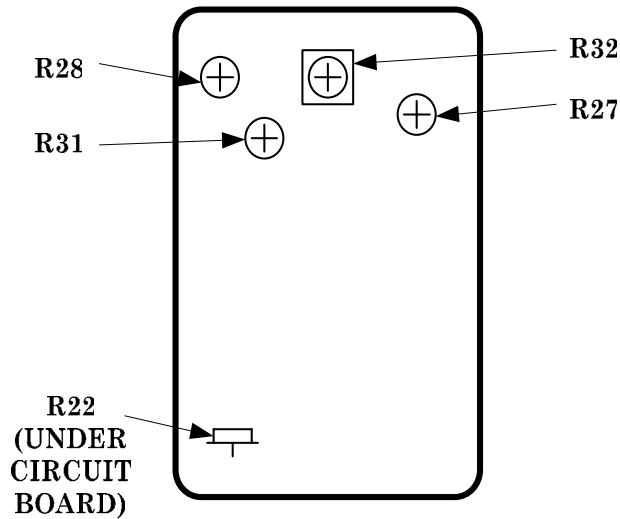

Figure 7. Simpson, Model 270.

Table 12a. Triplet, Model 310 Specifications

Test instrument parameter	Performance specification
Dc voltage	Range: 0 to 1200 V Accuracy: ±3% of FS
Ac voltage	Range: 0 to 1200 V Accuracy: ±4% of FS
Resistance	Range: 0 to 20 MΩ of dc scale Accuracy: ±3%
Dc current	Range: 0 to 600 mA Accuracy: ±3% of FS

**TB 9-6625-2352-35**

**Table 12b. Triplett, Model 310 Dc Voltage  
Calibration Performance Limits and Adjustments  
Dc Voltage**

Test instrument		Calibrator output			Test instrument
Dc volts range	Indication (V)	Initial output (V)	Limits		Adjustments
			Min	Max	
3	3	3	2.91	3.09	None
3	2	2	1.91	2.09	
3	1	1	0.91	1.09	
12	12	12	11.64	12.36	
60	60	60	58.2	61.8	
300	300	300	291	309	
1200 <sup>1</sup>	1200 (1000)	1200 (1000)	1164 (964)	1236 (1036)	

<sup>1</sup> Replace calibrator with power supply. Move positive lead to TI **1200 V DC** input. Calibrate at 1000 V if power supply not available. After 1200 V check is complete, reduce output to minimum, replace power supply with calibrator and move positive lead to TI **V-Ω-M** input.

**Table 12c. Triplett, Model 310 Ac Voltage  
Calibration Performance Limits and Adjustments  
Ac Voltage**

Test instrument		Calibrator			Test instrument
Ac volts range	Indication (V)	Initial output (V)	Frequency (Hz)	err indication ± (%)	Adjustments
12	12	12	60	4	
60	60	60	60	4	
300	300	300	60	4	
1200 <sup>1</sup>	1000	1000	60	4.8	

<sup>1</sup> Reduce output to minimum and move positive lead from TI **V-Ω-M** input to TI **1200 V AC** input. After 1200 V check is complete, reduce output to minimum and move positive lead to TI **V-Ω-M** input.

**Table 12d. Triplett, Model 310 Resistance  
Calibration Performance Limits and Adjustments  
Resistance**

Test instrument		Meter indications (0 to 300 dc scale)		Test instrument
Resistance standard setting (Ω)	Resistance ranges <sup>1</sup>	Min	Max	Adjustments
2000	X10	140	160	
20,000	X100	140	160	
200,000	X1K	140	160	

<sup>1</sup> Short leads and adjust **OHMS ADJ** for **0** indication on ohms scale. Repeat for each range.



Table 12e. Triplet, Model 310 Dc Current  
Calibration Performance Limits and Adjustments  
Dc Current

Test instrument		Calibrator		Test instrument
Dc current range	Indication (mA)	Initial output (mA)	err indication ± (%)	Adjustments
.6	.6	.6	3	None
6	6	6	3	
60	60	60	3	
600	600	600	3	

Table 13a. Triplet, Model 630 Specifications

Test instrument parameter	Performance specification <sup>1</sup>
Dc voltage	Range: 0 to 6000 V Accuracy: ±3% of FS for SN 208038 and below, (±5% of FS on 6000 V range); ±2% of FS for SN 208039 and above or no SN, (±4% of FS on 6000 V range)
Ac voltage	Range: 0 to 6000 V Accuracy: ±4% of FS for SN 208038 and below, (±5% of FS on 6000 V range); ±3% of FS for SN 208039 and above or no SN, (±4% of FS on 6000 V range)
Resistance	Range: 0 to 100 MΩ Accuracy: ±3% of scale length for SN 208038 and below ±2% of scale length for SN 208039 and above or no SN
Dc current	Range: 0 to 12 A Accuracy: ±3% of FS for SN 208038 and below, ±2% of FS for SN 208039 and above or no SN

<sup>1</sup> Indications in parentheses are for models 630, SN 20839 and above, and for models with no SN.

Table 13b. Triplet, Model 630 Dc Voltage  
Calibration Performance Limits and Adjustments  
Dc Voltage

Test instrument		Calibrator output			Test instrument
Dc volts range	Indication (V)	Initial output (V)	Limits <sup>1</sup>		Adjustments
			Min	Max	
3	3	3	2.91 (2.94)	3.09 (3.06)	None
12	12	12	11.64 (11.76)	12.36 (12.24)	
12	8	8	7.64 (7.76)	8.36 (8.24)	
12	4	4	3.64 (3.76)	4.36 (4.24)	
60	60	60	58.2 (58.8)	61.8 (61.2)	
300	300	300	291 (294)	309 (306)	
6000 <sup>2</sup>	6000	6000	5700 (5760)	6300 (6240)	

<sup>1</sup> Indications in parentheses are for models 630, SN 20839 and above, and for models with no SN.

<sup>2</sup> Move positive lead to TI **6000 V DC** input. Calibrate at 800 V with limits of 500 (560) and 1100 (1040) if power supply is not available. After 6000 V check is complete, reduce output to minimum, replace power supply with calibrator and move positive lead to TI **V-Ω-A** input.

**TB 9-6625-2352-35**

**Table 13c. Triplet, Model 630 Ac Voltage  
Calibration Performance Limits and Adjustments  
Ac Voltage**

Test instrument		Calibrator			Test instrument
Ac volts range	Indication (V)	Initial output (V)	Frequency (Hz)	err indication <sup>1</sup> ± (%)	Adjustments
3	3	3	60	4 (3)	None
12	12	12	60	4 (3)	
60	60	60	60	4 (3)	
300	300	300	60	4 (3)	
1200	1000	1000	60	4.8 (3.6)	
6000 <sup>2</sup>	800	800	60	37.5 (30)	

<sup>1</sup> Indications in parentheses are for models 630, SN 20839 and above, and for models with no SN.

<sup>2</sup> Move positive lead to TI **6000 V AC** input. After 6000 V check is complete, reduce output to minimum and move positive lead to TI **V-Ω-A** input.

**Table 13d. Triplet, Model 630 Resistance  
Calibration Performance Limits and Adjustments  
Resistance**

Test instrument		Resistance standard indications <sup>1</sup> (Ω)		Test instrument
Resistance range <sup>2</sup>	Indications ohms scale (Ω)	Min	Max	Adjustments
X1	4.4	3.88 (4.0)	4.90 (4.6)	None
X10	44	38.8 (40)	49.0 (46)	
X1000	4.4 k	3880 (4000)	4900 (4600)	
X100000	440 k	388 k (400 k)	490 k (460 k)	

<sup>1</sup> Indications in parentheses are for models 630, SN 20839 and above, and for models with no SN.

<sup>2</sup> Short leads and adjust **OHMS ADJ** for a **0** indication on ohms scale. Repeat for each range.

**Table 13e. Triplet, Model 630 Dc Current  
Calibration Performance Limits and Adjustments  
Dc Current**

Test instrument		Calibrator		Test instrument
Dc current range	Indication (A)	Initial output (A)	err indication <sup>1</sup> ± (%)	Adjustments
60 μA	60 μA	60 μA	3 (2)	None
1.2 mA	1.2 mA	1.2 mA	3 (2)	
12 mA	12 mA	12 mA	3 (2)	
120 mA	120 mA	120 mA	3 (2)	
12 A	10 A	10 A	3.6 (2.4)	

<sup>1</sup> Indications in parentheses are for models 630, SN 20839 and above, and for models with no SN.

**Table 14a. Triplet, Model 630NA Specifications**

Test instrument parameter	Performance specification
Dc voltage	Range: 0 to 6000 V Accuracy: ±1.5% of FS, ±3% of FS on 6000 V range
Ac voltage	Range: 0 to 6000 V Accuracy: ±3% of FS, ±4% of FS on 6000 V range
Resistance	Range: 0 to 100 MΩ Accuracy: ±1.5% of scale length
Dc current	Range: 0 to 12 A Accuracy: ±1.5% of FS

Table 14b. Triplet, Model 630NA Dc Voltage  
Calibration Performance Limits and Adjustments  
Dc Voltage

Test instrument		Calibrator output			Test instrument
Dc volts range	Indication (V)	Initial output (V)	Limits		Adjustments
			Min	Max	
.6	.6	.6	.591	.609	None
3	3	3	2.955	3.045	
3	2	2	1.955	2.045	
3	1	1	0.955	1.045	
12	12	12	11.82	12.18	
60	60	60	59.1	60.9	
300	300	300	295.5	304.5	
1200 <sup>1</sup>	1200 (1000)	1200 (1000)	1182 (982)	1218 (1018)	
6000 <sup>2</sup>	6000 (900)	6000 (900)	5820 (720)	6180 (1080)	

<sup>1</sup> Replace calibrator with power supply. Calibrate at 1000 V if power supply is not available.

<sup>2</sup> Reduce output to minimum and move positive lead to TI **6000 V DC** input. Calibrate at 900 V if power supply is not available. After 6000 V check is complete, reduce output to minimum, replace power supply with calibrator and move positive lead to TI **V-Ω-A** input.

Table 14c. Triplet, Model 630NA Ac Voltage  
Calibration Performance Limits and Adjustments  
Ac Voltage

Test instrument		Calibrator			Test instrument
Ac volts range	Indication (V)	Initial output (V)	Frequency (Hz)	err indication ± (%)	Adjustments (Fig. 8)
3	3	3	20 k	8	C3 (R)
12	12	12	60	3	----
60	60	60	60	3	----
300	300	300	60	3	----
1200	1000	1000	60	3.6	----
6000 <sup>1</sup>	800	800	60	30	----

<sup>1</sup> Reduce output to minimum and move positive lead to TI **6000 V AC** input. After 6000 V check is complete, reduce output to minimum and move positive lead to TI **V-Ω-A** input.

Table 14d. Triplet, Model 630NA Resistance  
Calibration Performance Limits and Adjustments  
Resistance

Test instrument		Resistance standard indications (Ω)		Test instrument
Resistance range <sup>1</sup>	Indications ohms scale (Ω)	Min	Max	Adjustments
X10	40	37	44	
X100	400	370	440	
X1K	4 k	3700	4400	
X10K	40 k	37 k	44 k	
X100K	400 k	370 k	440 k	

<sup>1</sup> Short leads and adjust **OHMS ADJ** for a **0** indication on ohms scale. Repeat for each range.

Table 14e. Triplet, Model 630NA Dc Current  
Calibration Performance Limits and Adjustments  
Dc Current

Test instrument		Calibrator		Test instrument
Dc current range	Indication (A)	Initial output (A)	err indication ± (%)	Adjustments
60 μA	60 μA	60 μA	1.5	None
.12 mA	.12 mA	.12 mA	1.5	
1.2 mA	1.2 mA	1.2 mA	1.5	
12 mA	12 mA	12 mA	1.5	
120 mA	120 mA	120 mA	1.5	
12 A	10 A	10 A	1.8	

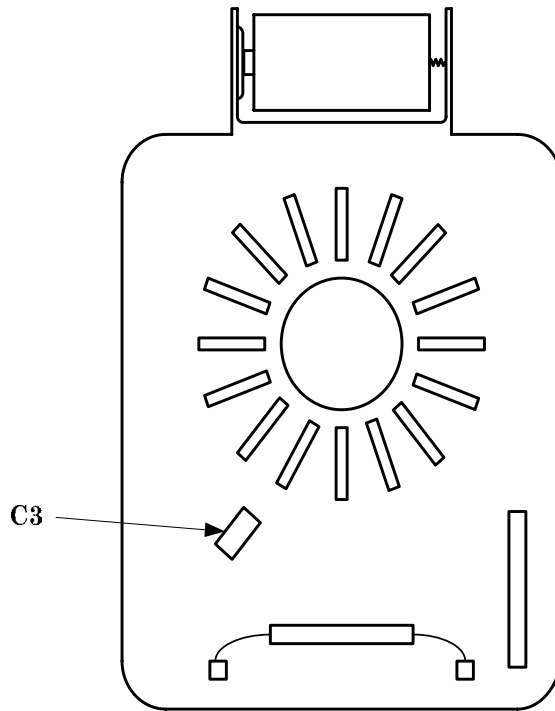

Figure 8. Triplet, Model 630NA.

Table 15a. Triplet, Model 630PL Specifications

Test instrument parameter	Performance specification
Dc voltage	Range: 0 to 5000 V Accuracy: ±3% of FS, ±5% of FS on 5000 V range
Ac voltage	Range: 0 to 6000 V Accuracy: ±4% of FS, ±5% of FS on 5000 V range
Resistance	Range: 0 to 100 MΩ Accuracy: ±3% of scale length
Dc current	Range: 0 to 12 A Accuracy: ±3% of FS

Table 15b. Triplett, Model 630PL Dc Voltage  
Calibration Performance Limits and Adjustments  
Dc Voltage

Test instrument		Calibrator output			Test instrument
Dc volts range	Indication (V)	Initial output (V)	Limits		Adjustments
			Min	Max	
2.5	2.5	2.5	2.425	2.575	None
10	10	10	9.7	10.3	
10	6	6	5.7	6.3	
10	2	2	1.7	2.3	
50	50	50	48.5	51.5	
250	250	250	242.5	257.5	
1000	1000	1000	970	1030	
5000 <sup>1</sup>	5000 (800)	5000 (800)	4750 (550)	5250 (1050)	

<sup>1</sup>Replace calibrator with power supply and move positive lead to TI **5000 V DC** input. Calibrate at 800 V if power supply is not available. After 5000 V check is complete, reduce output to minimum, replace power supply with calibrator and move positive lead to TI **V-Ω-A** input.

Table 15c. Triplett, Model 630PL Ac Voltage  
Calibration Performance Limits and Adjustments  
A Voltage

Test instrument		Calibrator			Test instrument
Ac volts range	Indication (V)	Initial output (V)	Frequency (Hz)	err indication ± (%)	Adjustments
10	10	10	60	4	
50	50	50	60	4	
250	250	250	60	4	
1000	1000	1000	60	4	
5000 <sup>1</sup>	800	800	60	31.25	

<sup>1</sup>Reduce output to minimum and move positive lead to TI **5000 V AC** input. After 5000 V check is complete, reduce output to minimum and move positive lead to TI **V-Ω-A** input.

Table 15d. Triplett, Model 630PL Resistance  
Calibration Performance Limits and Adjustments  
Resistance

Test instrument		Resistance standard indications (Ω)		Test instrument
Resistance Range <sup>1</sup>	Indications ohms scale (Ω)	Min	Max	Adjustments
X10	40	37	44	
X1K	4 K	3.7 k	4.4 k	
X100K	400 K	370 k	440 k	

<sup>1</sup>Short leads and adjust **Ω ADJ** for a **0** indication on ohms scale. Repeat for each range.

**TB 9-6625-2352-35**

**Table 15e. Triplet, Model 630PL Dc Current  
Calibration Performance Limits and Adjustments  
Dc Current**

Test instrument		Calibrator		Test instrument
Dc current range	Indication (A)	Initial output (A)	err indication ± (%)	Adjustments
100 μA	100 μA	100 μA	3	None
10 mA	10 mA	10 mA	3	
100 mA	100 mA	100 mA	3	
1 A	1 A	1 A	3	
10 A	10 A	10 A	3	

**Table 16a. Triplet, Model 666R Specifications**

Test instrument parameter	Performance specification
Dc voltage	Range: 0 to 1000 V; 1000 to 5000 V Accuracy: ±3% of FS, ±4% of FS on 5000 V range
Ac voltage	Range: 0 to 1000 V; 1000 to 5000 V Accuracy: ±4% of FS, ±5% of FS on 5000 V range
Resistance	Range: 0 to 3 MΩ Accuracy: ±3% of arc length (1.5 div on dc scale)
Dc current	Range: 0 to 1 A Accuracy: ±3% of FS

**Table 16b. Triplet, Model 666R Dc Voltage  
Calibration Performance Limits and Adjustments  
Dc Voltage**

Test instrument		Calibrator output		Test instrument	
Dc volts range	Indication (V)	Initial output (V)	Limits		Adjustments
			Min	Max	
10	10	10	9.7	10.3	None
10	6	6	5.7	6.3	
10	2	2	1.7	2.3	
50	50	50	48.5	51.5	
250	250	250	242.5	257.5	
1000	1000	1000	970	1030	
5000 <sup>1</sup>	5000 (900)	5000 (900)	4800 (700)	5200 (1100)	

<sup>1</sup> Replace calibrator with power supply and move positive lead to TI **5000 V** input. Calibrate at 900 V if power supply is not available. After 5000 V check is complete, reduce output to minimum, replace power supply with calibrator and move positive lead to TI **V-Ω-A** input.

**Table 16c. Triplet, Model 666R Ac Voltage  
Calibration Performance Limits and Adjustments  
Ac Voltage**

Test instrument		Calibrator		Test instrument	
Ac volts range	Indication (V)	Initial output (V)	Frequency (Hz)	err indication ± (%)	Adjustments
10	10	10	60	4	None
50	50	50	60	4	
250	250	250	60	4	
1000	1000	1000	60	4	
5000 <sup>1</sup>	800	800	60	31.25	

<sup>1</sup> Reduce output to minimum and move positive lead to TI **5000 V AC** input. After 5000 V check is complete, reduce output to minimum and move positive lead to TI **V-Ω-A** input.

Table 16d. Triplet, Model 666R Resistance  
Calibration Performance Limits and Adjustments  
Resistance

Test instrument		Meter indications (0 to 50 dc scale)		Test instrument
Resistance standard setting (Ω)	Resistance ranges <sup>1</sup>	Min	Max	Adjustments
20	X1	23.5	26.5	None
2000	X100	23.5	26.5	
20,000	X1000	23.5	26.5	

<sup>1</sup>Short leads and adjust **OHMS ADJ** for **0** indication on ohms scale. Repeat for each range.

Table 16e. Triplet, Model 666R Dc Current  
Calibration Performance Limits and Adjustments  
Dc Current

Test instrument		Calibrator		Test instrument
Dc current range	Indication (A)	Initial output (A)	<b>err</b> indication ± (%)	Adjustments
10 mA	10 mA	10 mA	3	None
100 mA	100 mA	100 mA	3	
500 mA	500 mA	500 mA	3	
1 A <sup>1</sup>	1 A	1 A	3	

<sup>1</sup> Reduce output to minimum and move positive lead to TI **1 AMP** input.

## 12. Final Procedure

- a. Deenergize and disconnect all equipment.
- b. Annotate and affix DA label/form in accordance with TB 750-25.





By Order of the Secretary of the Army:

Official

  
SANDRA R. RILEY  
*Administrative Assistant to the  
Secretary of the Army*

PETER J. SCHOOMAKER  
*General, United States Army  
Chief of Staff*

0509701

Distribution:

To be distributed in accordance with the initial distribution number (IDN) 344796,  
requirements for calibration procedure TB 9-6625-2352-35.

### Instructions for Submitting an Electronic 2028

The following format must be used if submitting an electronic 2028. The subject line must be exactly the same and all fields must be included; however, only the following fields are mandatory: 1, 3, 4, 5, 6, 7, 8, 9, 10, 13, 15, 16, 17, and 27.

From: "Whomever" [whomever@redstone.army.mil](mailto:whomever@redstone.army.mil)  
To: <2028@redstone.army.mil

Subject: DA Form 2028

1. **From:** Joe Smith
2. **Unit:** home
3. **Address:** 4300 Park
4. **City:** Hometown
5. **St:** MO
6. **Zip:** 77777
7. **Date Sent:** 19-OCT -93
8. **Pub no:** 55-2840-229-23
9. **Pub Title:** TM
10. **Publication Date:** 04-JUL-85
11. **Change Number:** 7
12. **Submitter Rank:** MSG
13. **Submitter FName:** Joe
14. **Submitter MName:** T
15. **Submitter LName:** Smith
16. **Submitter Phone:** 123-123-1234
17. **Problem:** 1
18. **Page:** 2
19. **Paragraph:** 3
20. **Line:** 4
21. **NSN:** 5
22. **Reference:** 6
23. **Figure:** 7
24. **Table:** 8
25. **Item:** 9
26. **Total:** 123
27. **Text**

This is the text for the problem below line 27.

